

Dimensiones/Dimensions

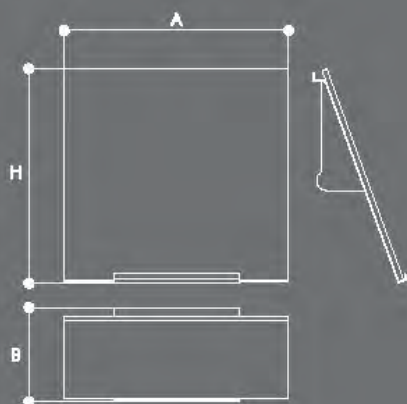

Acabados de serie opcionales/Optional finishes series



Blanco/White Plata/Silver Grafito/Graphite Negro/Black

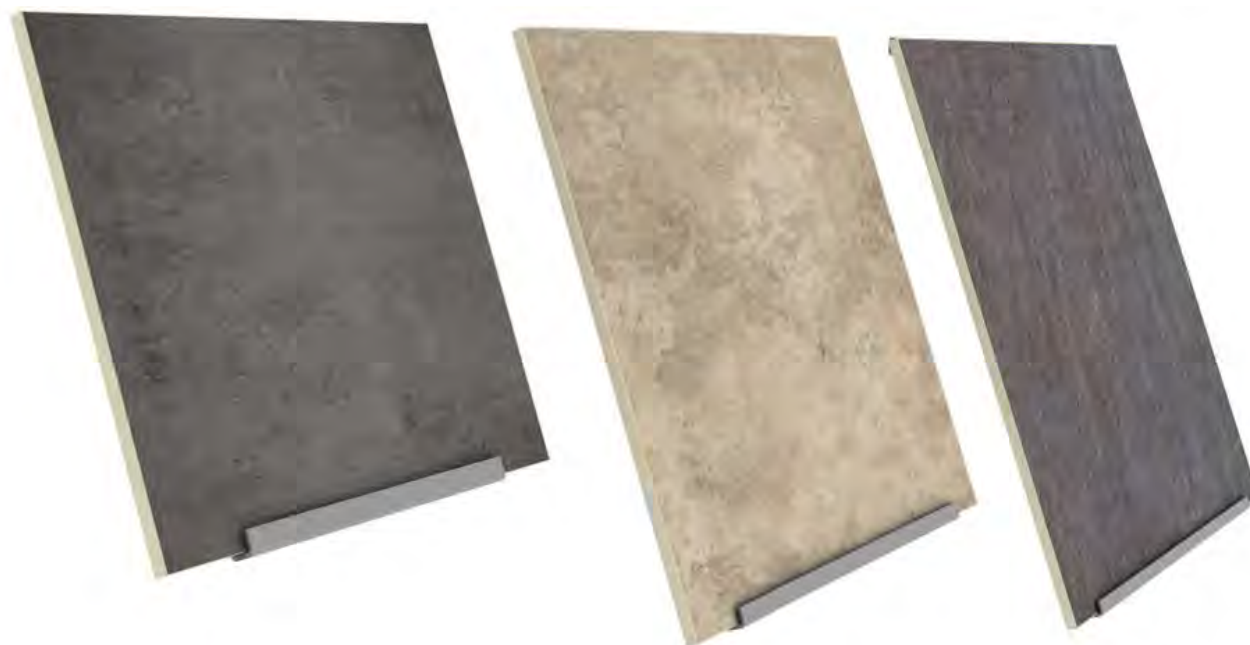

Imagen/Image
Tray 300-450-600

modelo
model

dimensiones (mm)
dimensions

A B H

Tray 300

200 135 275

Tray 450

350 185 415

Tray 600

500 235 560

Elemento que siempre se utilizará como parte de un conjunto. Las dimensiones del conjunto, del embalaje y el peso, variarán dependiendo de la composición.

Element that will always be used as a part of a set in a technical area/wall.

Measures of the set, packing and weight would change depending of the choice of the elements.



Dimensiones/Dimensions

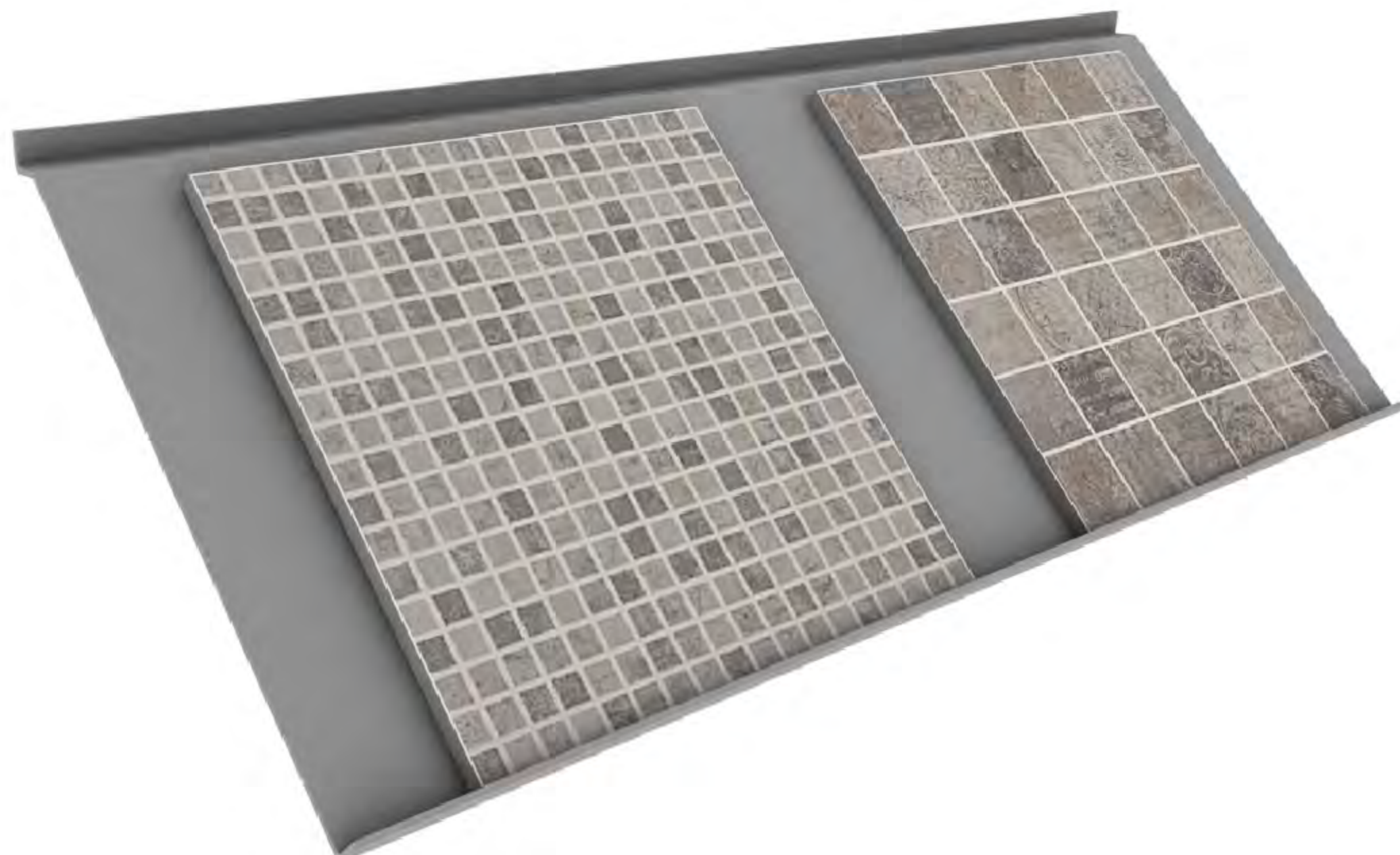

Acabados de serie opcionales/Optional finishes series



Blanco/White Plata/Silver Grafito/Graphite Negro/Black

Imagen/Image
tray 300x800

altura máxima de las piezas (mm)
maximum height of the tiles

dimensiones expositor (mm)
display dimensions

Elemento que siempre se utilizará como parte de un conjunto.
Las dimensiones del conjunto, del embalaje y el peso, variarán
dependiendo de la composición.

300

A	B	H
800	250	230

Element that will always be used as a part of a set in a
technical area/wall.

Measures of the set, packing and weight would change
depending of the choice of the elements.

Dimensiones/Dimensions

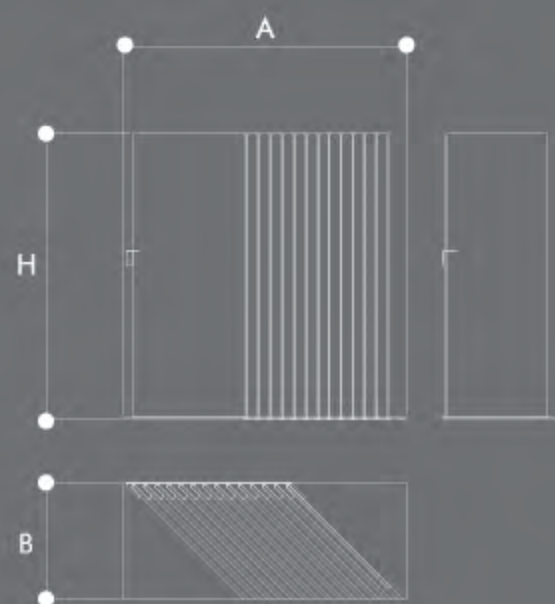

Acabados de serie opcionales/Optional finishes series



Blanco/White Plata/Silver Grafito/Graphite Negro/Black

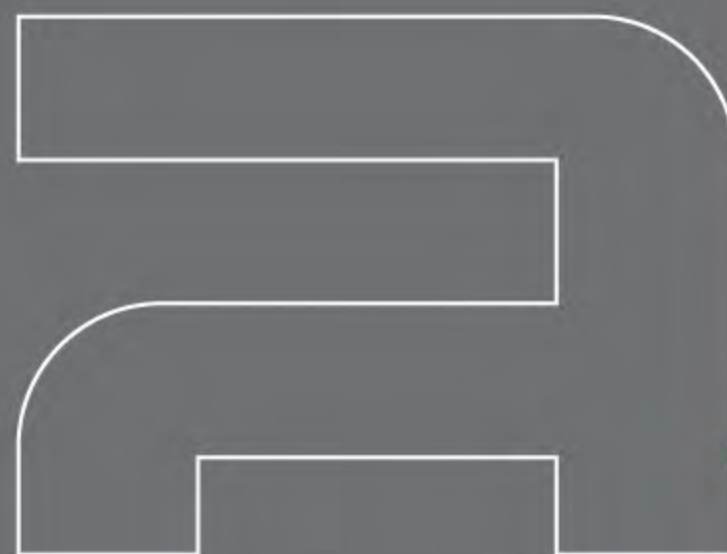

Imagen/Image
Edfu 14P dcha

n° de piezas No. tiles	variaciones variations	dimensiones expositor (mm) display dimensions		
		A	B	H
14P	inclinación a derecha	1191	490	700
14P	inclinación a izquierda	1191	490	700

Elemento que siempre se utilizará como parte de un conjunto. Las dimensiones del conjunto, del embalaje y el peso, variarán dependiendo de la composición.

Element that will always be used as a part of a set in a technical area/wall. Measures of the set, packing and weight would change depending of the choice of the elements.

Dimensiones/Dimensions

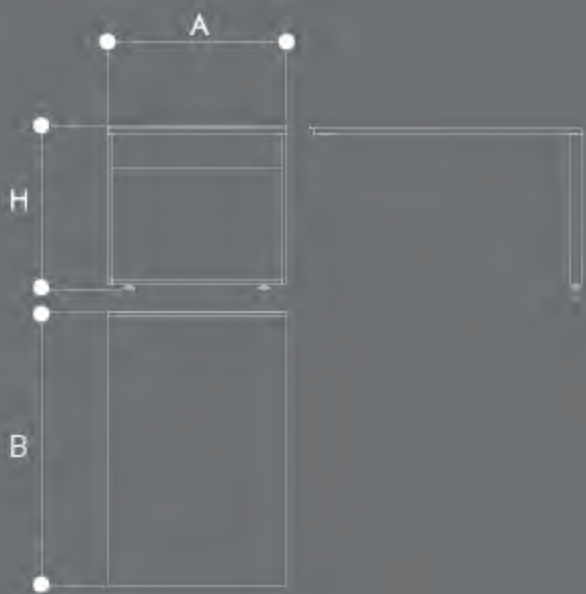

Acabados de serie opcionales/Optional finishes series



Blanco/White Plata/Silver Grafito/Graphite Negro/Black



Imagen/Image
Work Table

dimensiones expositor (mm)
display dimensions

A	B	H
800	1200	725

Elemento que siempre se utilizará como parte de un conjunto.
Las dimensiones del conjunto, del embalaje y el peso, variarán
dependiendo de la composición.

Element that will always be used as a part of a set in a
technical area/wall.

Measures of the set, packing and weight would change
depending of the choice of the elements.

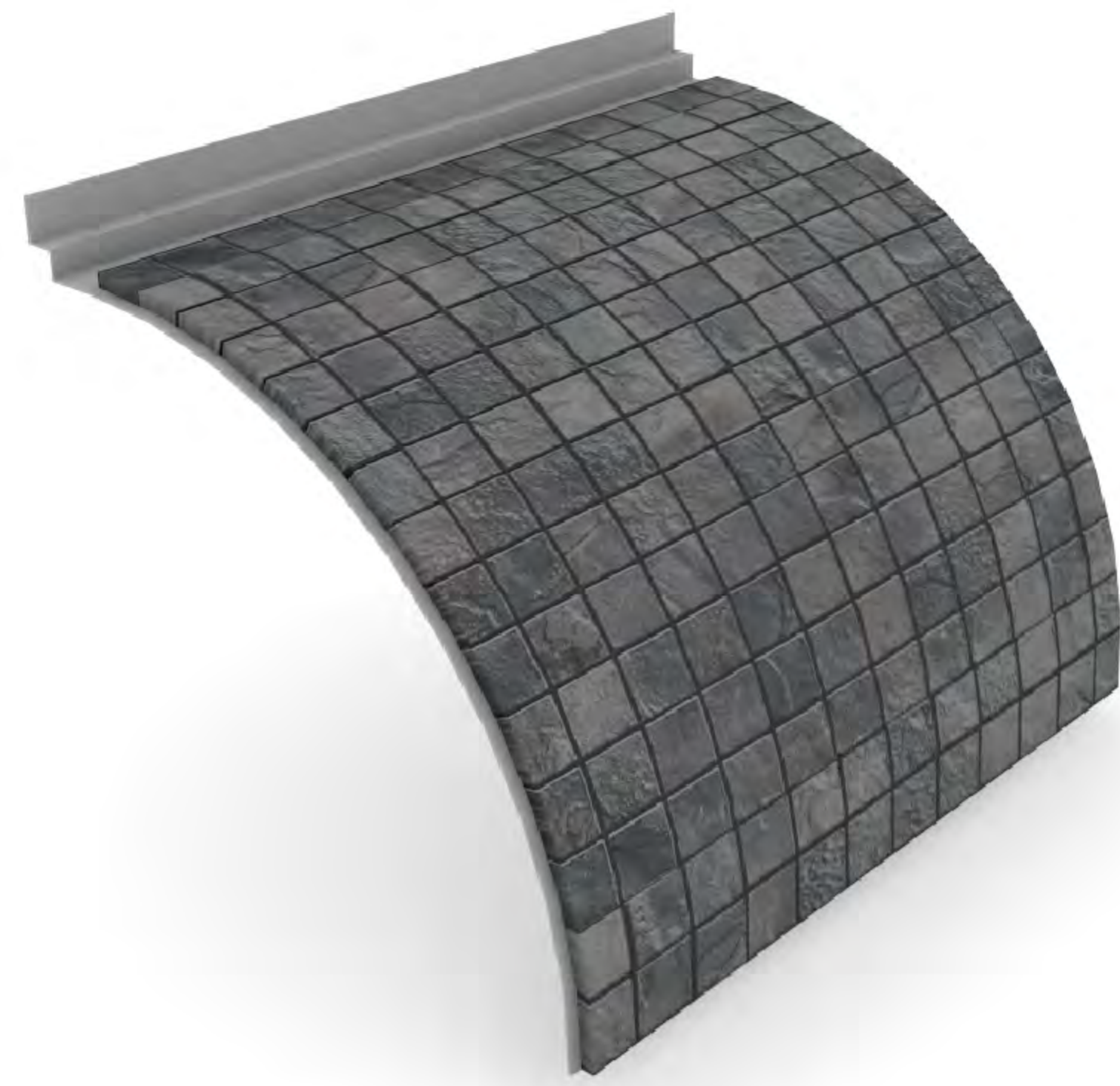

Imagen/Image
Wave

Dimensiones/Dimensions

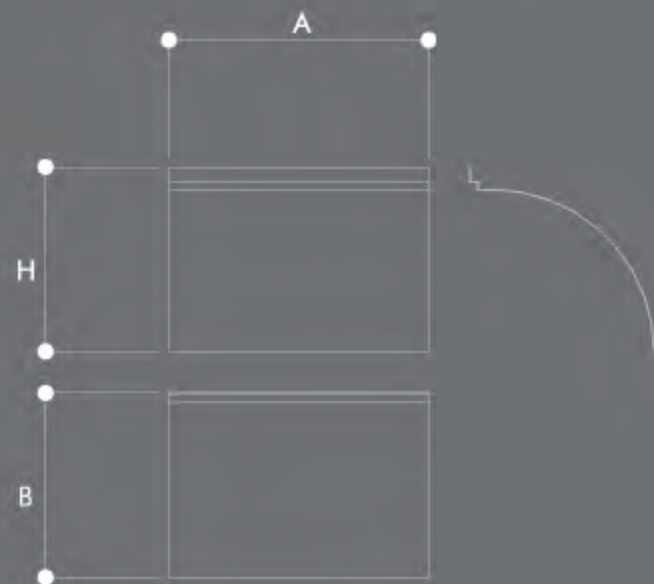

Acabados de serie opcionales/Optional finishes series

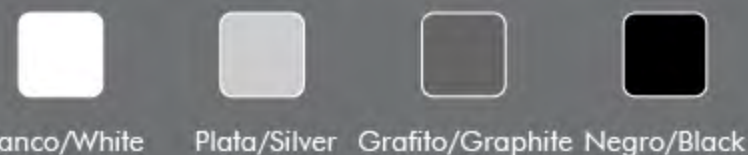

Blanco/White Plata/Silver Grafito/Graphite Negro/Black

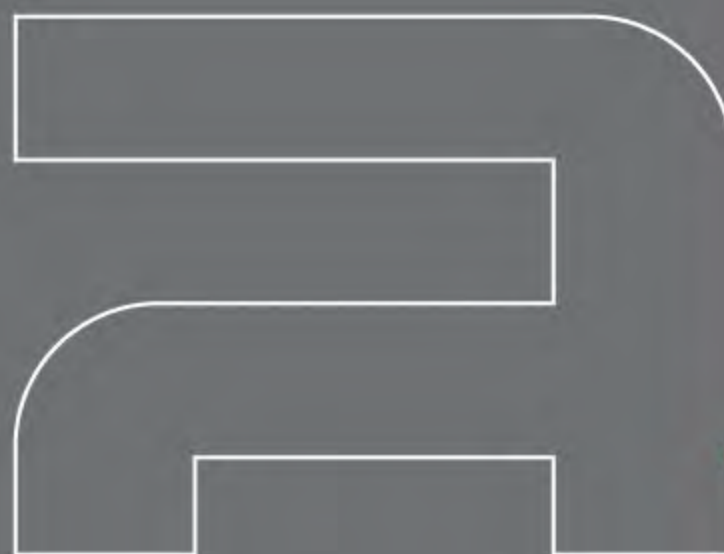

n° de piezas No. tiles	dimensiones de la pieza (mm) tile dimensions	dimensiones expositor (mm) display dimensions		
		A	B	H
1P	310x310	320	230	225

Elemento que siempre se utilizará como parte de un conjunto. Las dimensiones del conjunto, del embalaje y el peso, variarán dependiendo de la composición.

Element that will always be used as a part of a set in a technical area/wall. Measures of the set, packing and weight would change depending of the choice of the elements.





Imagen/Image
Hanger 6P

Dimensiones/Dimensions

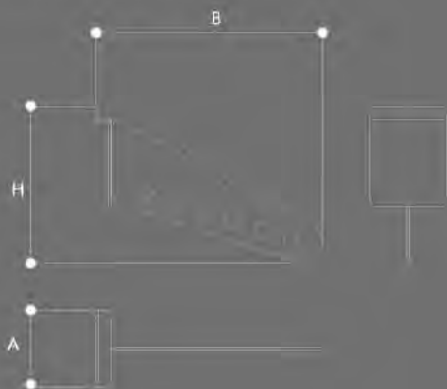

Acabados de serie opcionales/Optional finishes series



Blanco/White Plata/Silver Grafita/Graphite Negro/Black

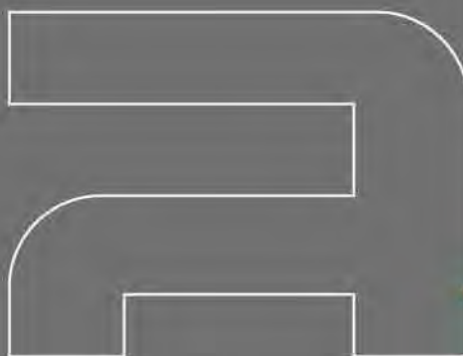

perchas para piezas
rack tile

dimensiones (mm)
dimensions

	A	B	H
6	50	253	170

Elemento que siempre se utilizará como parte de un conjunto.
Las dimensiones del conjunto, del embalaje y el peso, variarán
dependiendo de la composición.

Element that will always be used as a part of a set in a
technical area/wall.
Measures of the set, packing and weight would change
depending of the choice of the elements.

Dimensiones/Dimensions

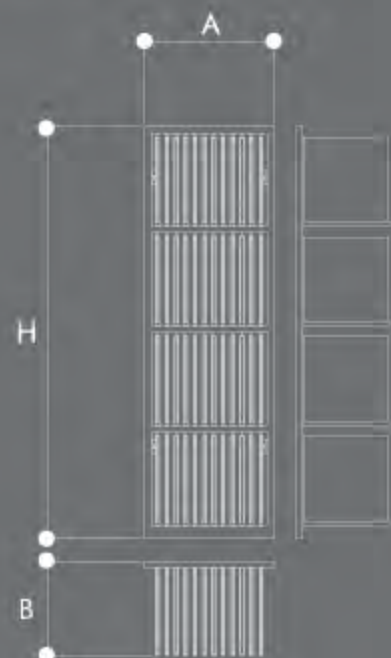

Acabados de serie opcionales/Optional finishes series

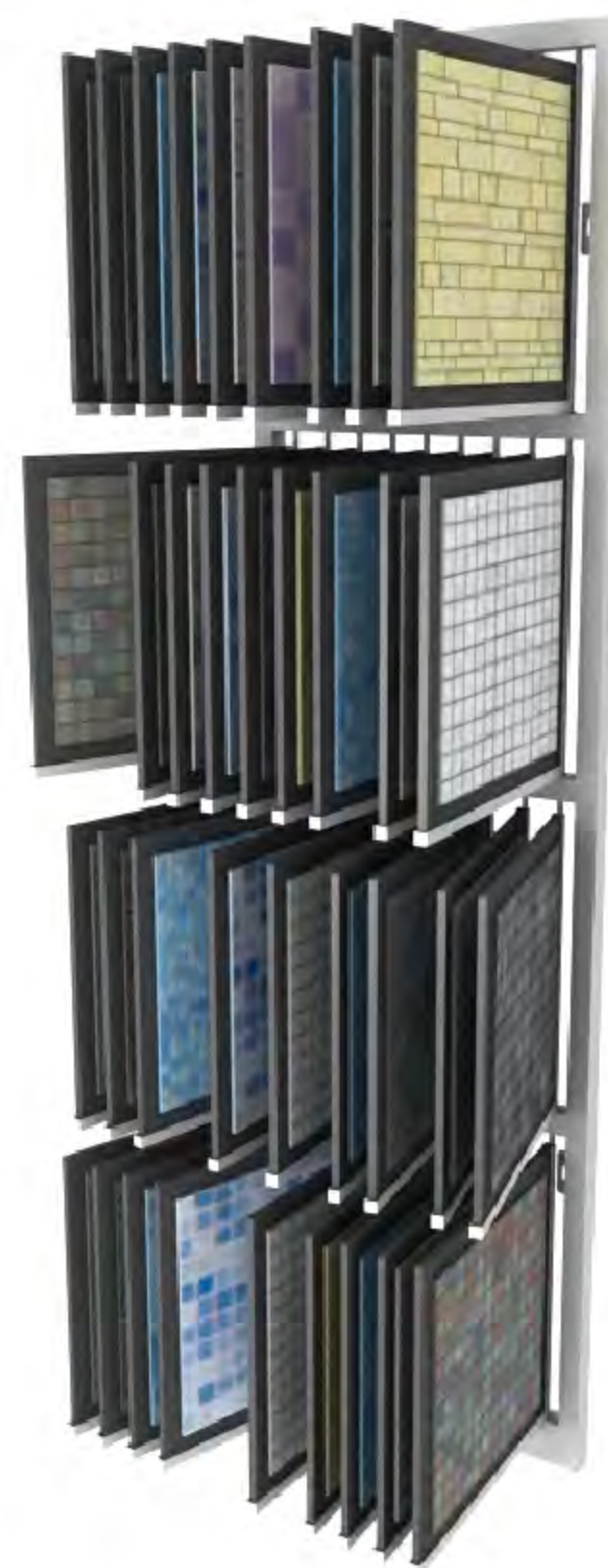

Imagen/Image
File Tile

n° de piezas No. tiles	dim. máx. de la pieza (mm) maximum dimension tile	dimensiones expositor (mm) display dimensions		
		A	B	H
72P	350x350	515	420	1840

Elemento que siempre se utilizará como parte de un conjunto. Las dimensiones del conjunto, del embalaje y el peso, variarán dependiendo de la composición.

Element that will always be used as a part of a set in a technical area/wall. Measures of the set, packing and weight would change depending of the choice of the elements.

Dimensiones/Dimensions

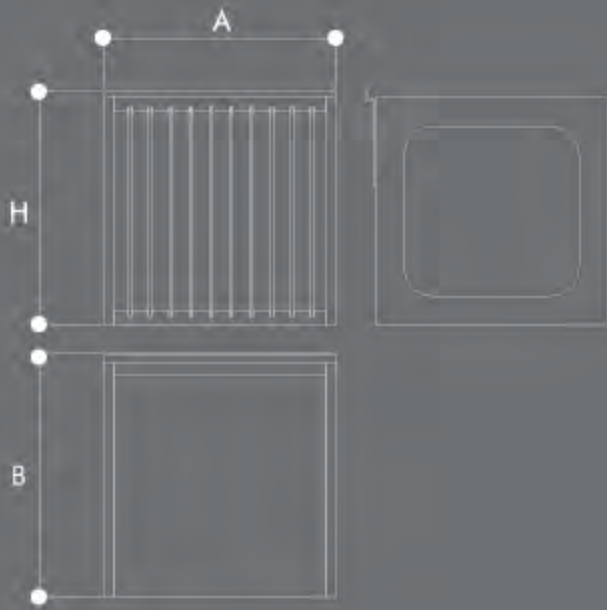

Acabados de serie opcionales/Optional finishes series



Blanco/White Plata/Silver Grafito/Graphite Negro/Black



Imagen/Image
Cube 10P-300x300

n° de piezas No. tiles	dimensiones de la pieza (mm) tile size	dimensiones expositor (mm) display dimensions		
		A	B	H
10P	300	403	403	394

Elemento que siempre se utilizará como parte de un conjunto. Las dimensiones del conjunto, del embalaje y el peso, variarán dependiendo de la composición.

Element that will always be used as a part of a set in a technical area/wall.

Measures of the set, packing and weight would change depending of the choice of the elements.

Dimensiones/Dimensions

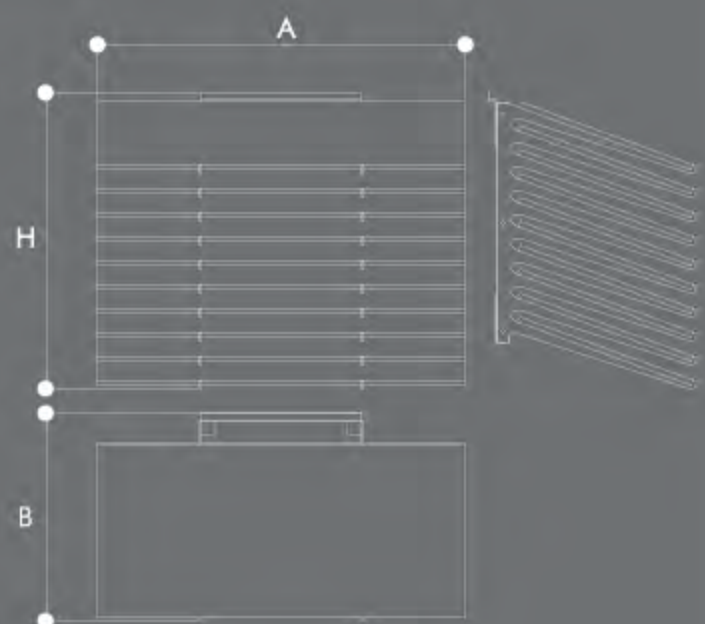

Acabados de serie opcionales/Optional finishes series

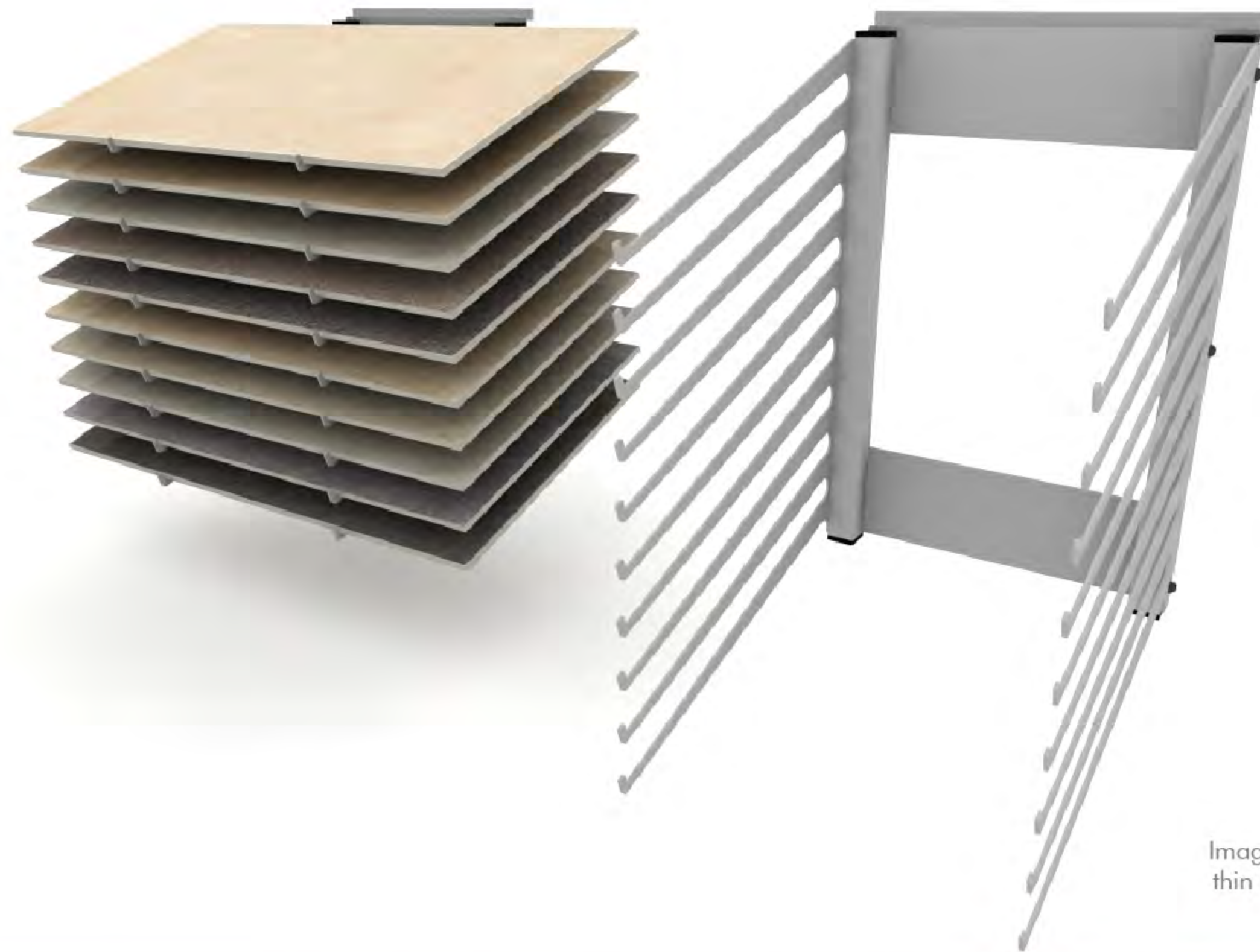

Imagen/Image
thin 10P - 400

n° de piezas No. tiles	dimensiones de la pieza (mm) tile dimensions	dimensiones (mm) dimensions		
		A	B	H
6P	400x800	356	440	605
10P	400x800	356	440	645

Elemento que siempre se utilizará como parte de un conjunto. Las dimensiones del conjunto, del embalaje y el peso, variarán dependiendo de la composición.

Element that will always be used as a part of a set in a technical area/wall. Measures of the set, packing and weight would change depending of the choice of the elements.



Dimensiones/Dimensions

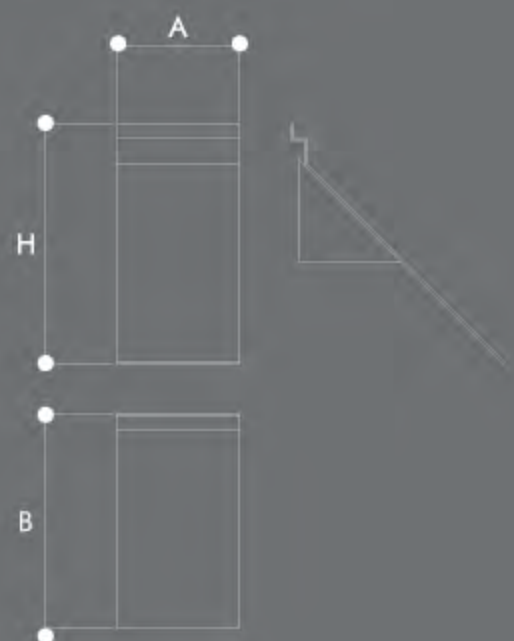

Acabados de serie opcionales/Optional finishes series



Blanco/White Plata/Silver Grafito/Graphite Negro/Black

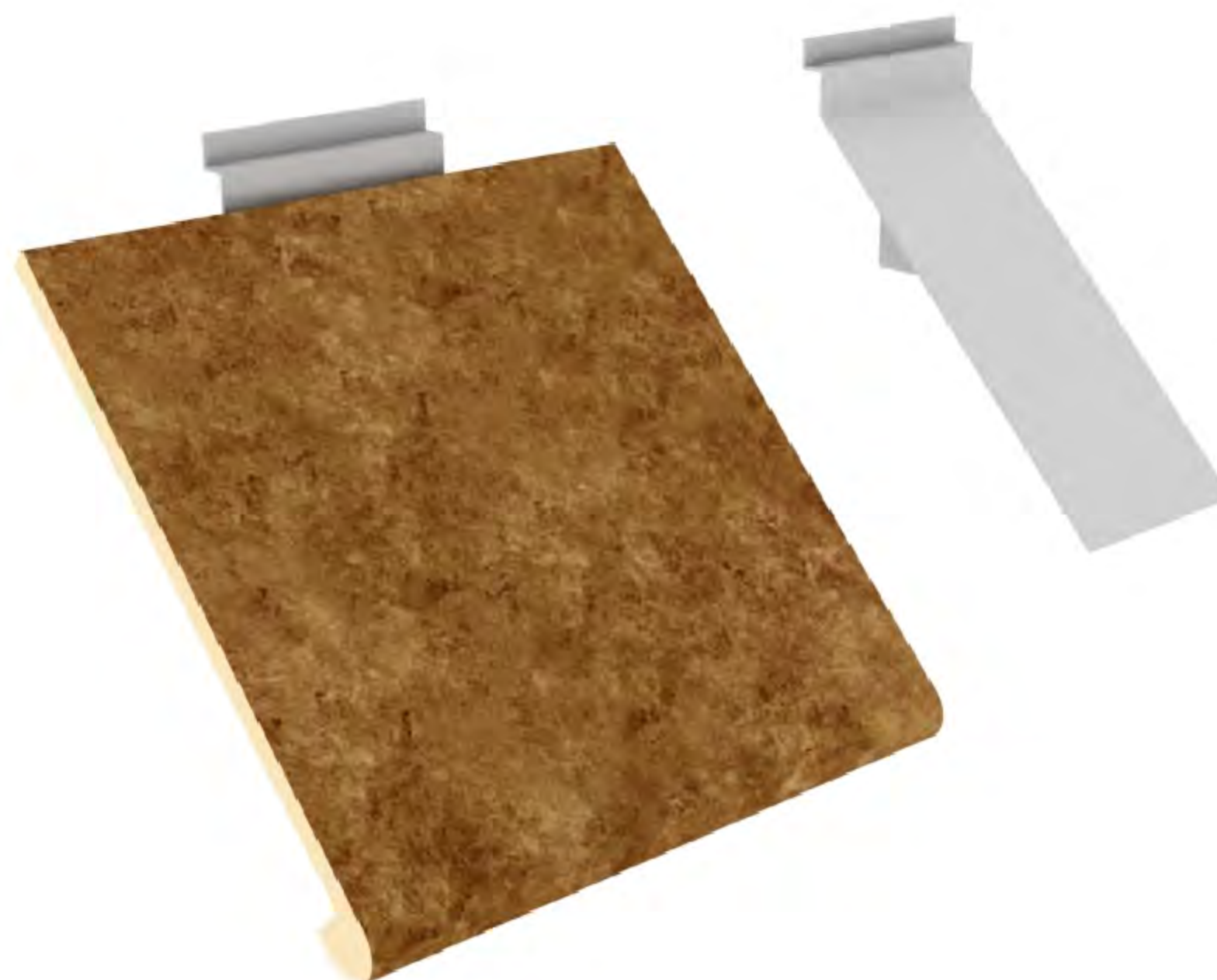

Imagen/Image
Step Support

n° de piezas
No. tiles

dimensiones (mm)
dimensions

A	B	H
120	210	230

Elemento que siempre se utilizará como parte de un conjunto. Las dimensiones del conjunto, del embalaje y el peso, variarán dependiendo de la composición.

Element that will always be used as a part of a set in a technical area/wall.

Measures of the set, packing and weight would change depending of the choice of the elements.

Dimensiones/Dimensions

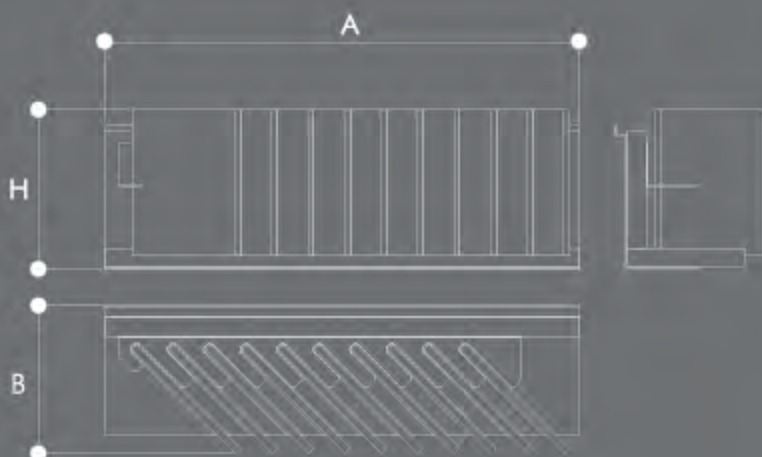

Acabados de serie opcionales/Optional finishes series

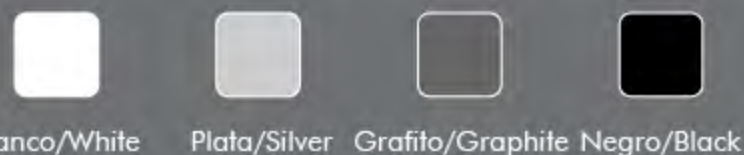

Imagen/Image
Row-Ob 10P-200x200 dcha

n° de piezas No. tiles	dimensiones de la pieza (mm) tile dimensions	variaciones variations	dimensiones expositor (mm) display dimensions		
			A	B	H
10P	200x200	inclinación a derecha	650	160	190
10P	200x200	inclinación a izquierda	650	160	190

Elemento que siempre se utilizará como parte de un conjunto.

Las dimensiones del conjunto, del embalaje y el peso, variarán dependiendo de la composición.

Element that will always be used as a part of a set in a technical area/wall.

Measures of the set, packing and weight would change depending of the choice of the elements.



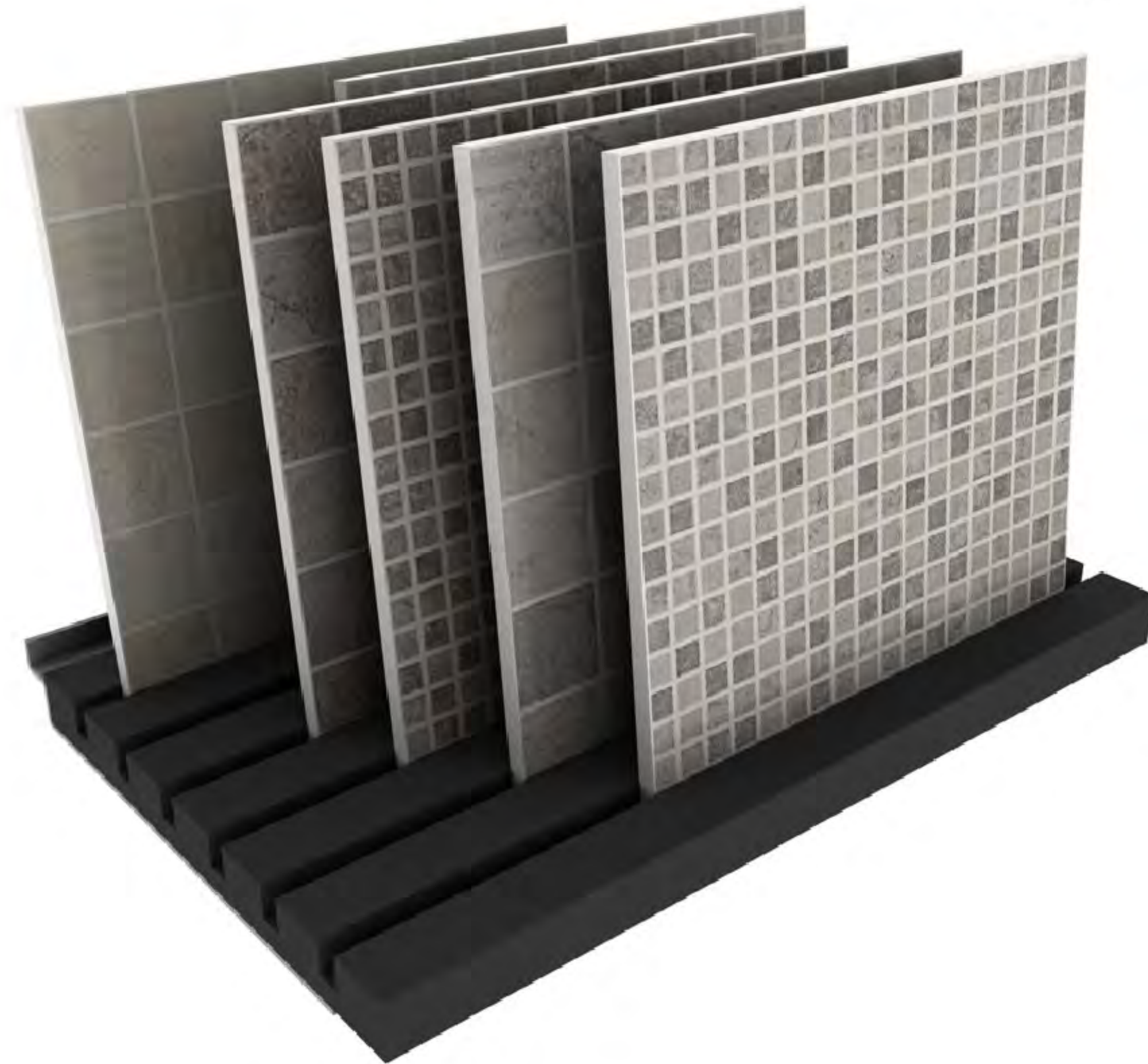

Imagen/Image
Row 6P-500

dimensiones expositor (mm)
display dimensions

A	B	H
500	315	105

Elemento que siempre se utilizará como parte de un conjunto.
Las dimensiones del conjunto, del embalaje y el peso, variarán
dependiendo de la composición.

Element that will always be used as a part of a set in a
technical area/wall.

Measures of the set, packing and weight would change
depending of the choice of the elements.

Dimensiones/Dimensions

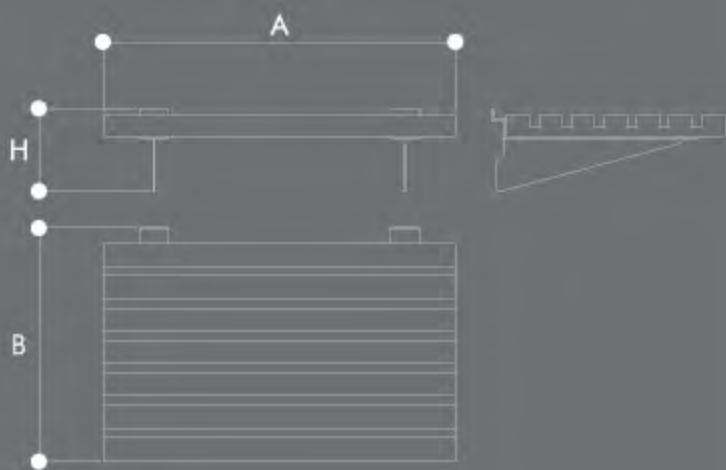

Acabados de serie opcionales/Optional finishes series



Blanco/White Plata/Silver Grafito/Graphite Negro/Black



Dimensiones/Dimensions

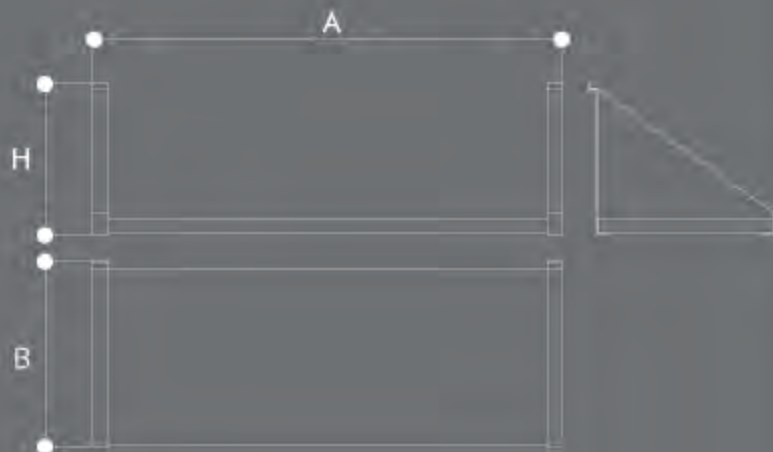

Acabados de serie opcionales/Optional finishes series



Blanco/White Plata/Silver Grafito/Graphite Negro/Black



Imagen/Image
Rack B-900

dimensiones expositor (mm)
display dimensions

A	B	H
900	343	293

Elemento que siempre se utilizará como parte de un conjunto.
Las dimensiones del conjunto, del embalaje y el peso, variarán
dependiendo de la composición.

Element that will always be used as a part of a set in a
technical area/wall.

Measures of the set, packing and weight would change
depending of the choice of the elements.

Dimensiones/Dimensions

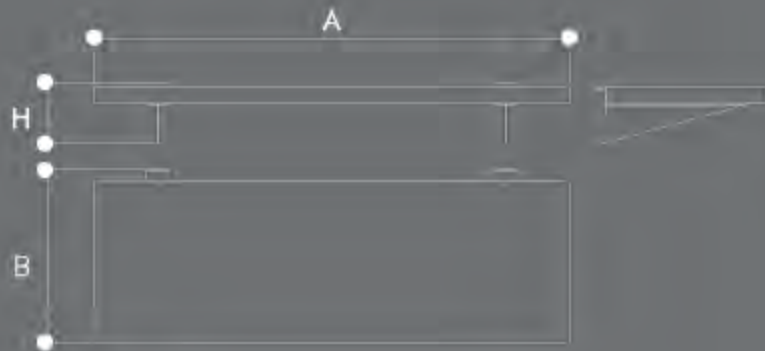

Acabados de serie opcionales/Optional finishes series



Blanco/White Plata/Silver Grafito/Graphite Negro/Black

Imagen/Image
Rack A-900

dimensiones expositor (mm)
display dimensions

A	B	H
900	319	115

Elemento que siempre se utilizará como parte de un conjunto.
Las dimensiones del conjunto, del embalaje y el peso, variarán
dependiendo de la composición.

Element that will always be used as a part of a set in a
technical area/wall.

Measures of the set, packing and weight would change
depending of the choice of the elements.





Imagen/Image
Lineal 15P-800

Dimensiones/Dimensions

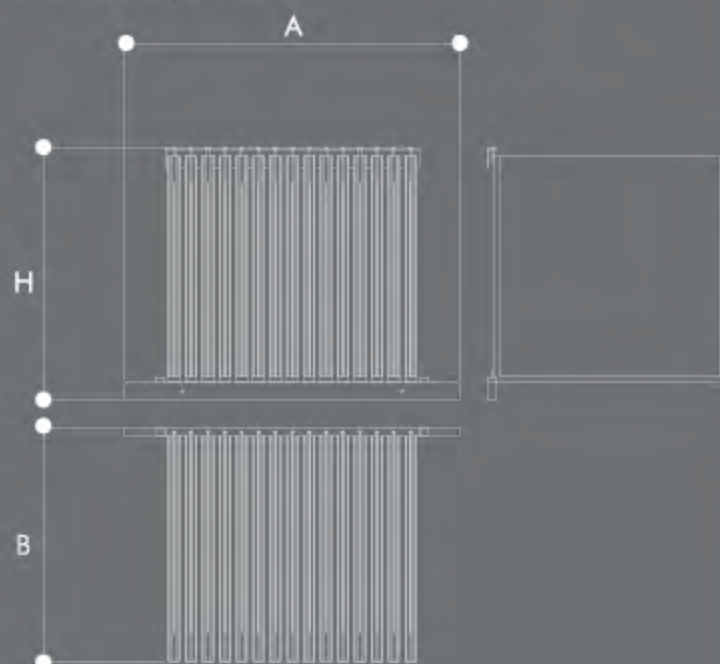

Acabados de serie opcionales/Optional finishes series

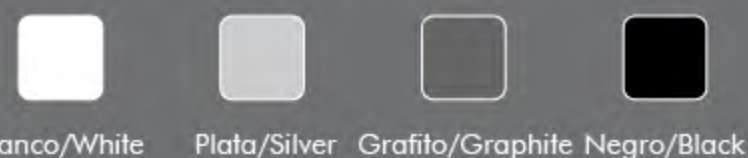

Blanco/White Plata/Silver Grafito/Graphite Negro/Black

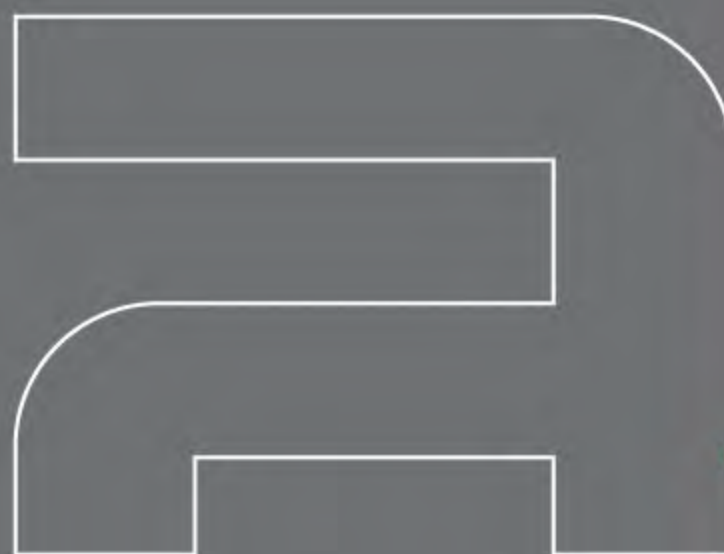

n° de piezas No. tiles	dim. máx. de la pieza (mm) maximum dimension tile	dimensiones expositor (mm) display dimensions		
		A	B	H
14P	600x600	581	629	697
14P	800x800	581	829	897
30P	600x600	1180	629	697
30P	800x800	1180	829	897

Elemento que siempre se utilizará como parte de un conjunto. Las dimensiones del conjunto, del embalaje y el peso, variarán dependiendo de la composición.

Element that will always be used as a part of a set in a technical area/wall. Measures of the set, packing and weight would change depending of the choice of the elements.



Imagen/Image
File 10P-400

Dimensiones/Dimensions

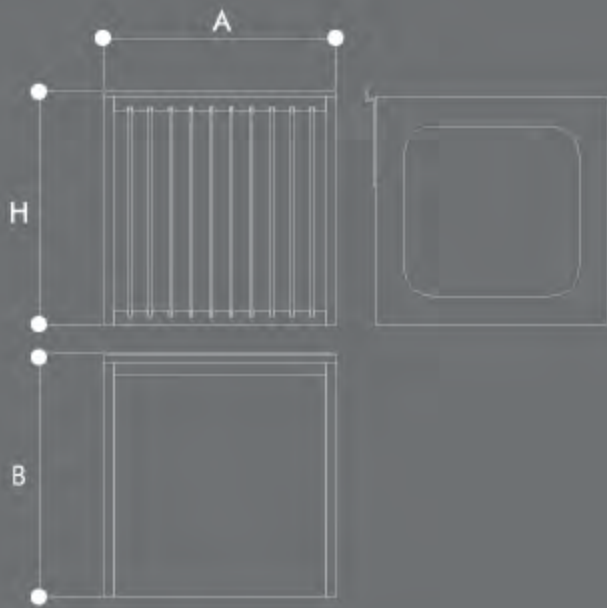

Acabados de serie opcionales/Optional finishes series

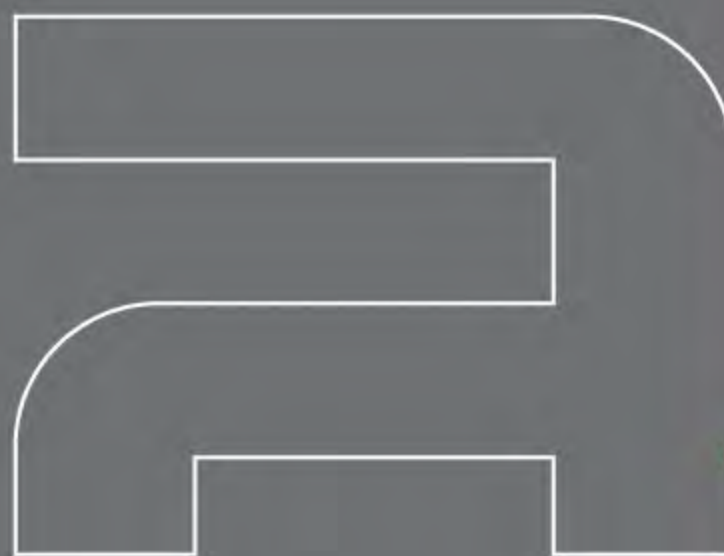
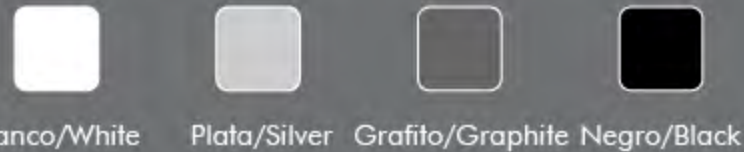

n° de piezas No. tiles	altura máxima de la pieza (mm) maximum height of the tile	dimensiones expositor (mm) display dimensions		
		A	B	H
10P	400	492	343	293

Elemento que siempre se utilizará como parte de un conjunto. Las dimensiones del conjunto, del embalaje y el peso, variarán dependiendo de la composición.

Element that will always be used as a part of a set in a technical area/wall. Measures of the set, packing and weight would change depending of the choice of the elements.



Dimensiones/Dimensions

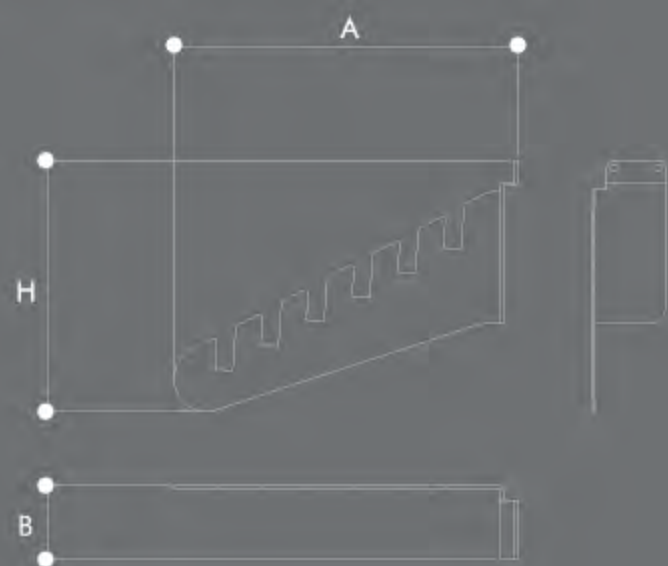

Acabados de serie opcionales/Optional finishes series



Blanco/White



Plata/Silver



Grafito/Graphite



Negro/Black



Imagen/Image
Comb 6P

n° de piezas No. tiles	altura máxima de las piezas (mm) maximum height of the tiles	dimensiones expositor (mm) display dimensions		
		A	B	H
6P	300	50	230	155

Elemento que siempre se utilizará como parte de un conjunto. Las dimensiones del conjunto, del embalaje y el peso, variarán dependiendo de la composición.

Element that will always be used as a part of a set in a technical area/wall. Measures of the set, packing and weight would change depending of the choice of the elements.



Dimensiones/Dimensions



Acabados de serie opcionales/Optional finishes series



Blanco/White Plata/Silver Grafito/Graphite Negro/Black



Imagen/Image
Comb 4P

nº de piezas No. tiles	altura máxima de las piezas (mm) maximum height of the tiles	dimensiones expositor (mm) display dimensions		
		A	B	H
4P	600	50	190	205

Elemento que siempre se utilizará como parte de un conjunto. Las dimensiones del conjunto, del embalaje y el peso, variarán dependiendo de la composición.

Element that will always be used as a part of a set in a technical area/wall. Measures of the set, packing and weight would change depending of the choice of the elements.



Dimensiones/Dimensions



Acabados de serie opcionales/Optional finishes series



Blanco/White Plata/Silver Grafito/Graphite Negro/Black

Iluminación de serie opcional/Optional lighting series

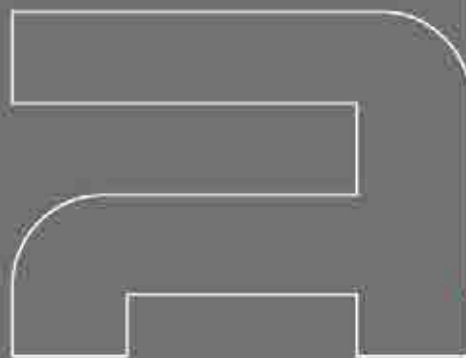

Imagen/Image
Cluster 9P

nº de piezas
No. files

dimensiones expositor (mm)
display dimensions

A B H

7P 120 75 393

9P 120 75 474

14P 120 75 709

20P 120 75 979

Elemento que siempre se utilizará como parte de un conjunto.
Las dimensiones del conjunto, del embalaje y el peso, variarán
dependiendo de la composición.

Element that will always be used as a part of a set in a technical area/wall.
Measures of the set, packing and weight would change depending of the
choice of the elements.

Dimensiones/Dimensions

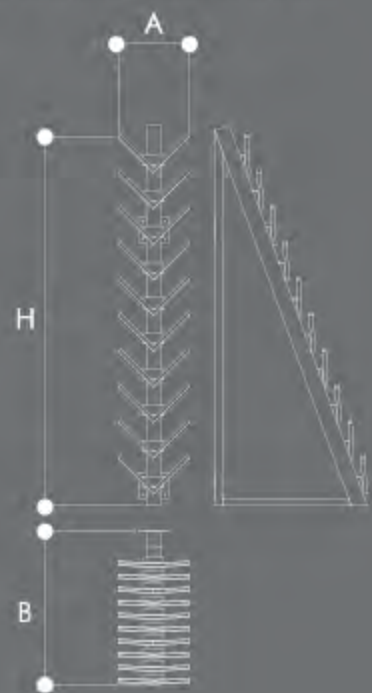

Acabados de serie opcionales/Optional finishes series



Imagen/Image
Fall 10P

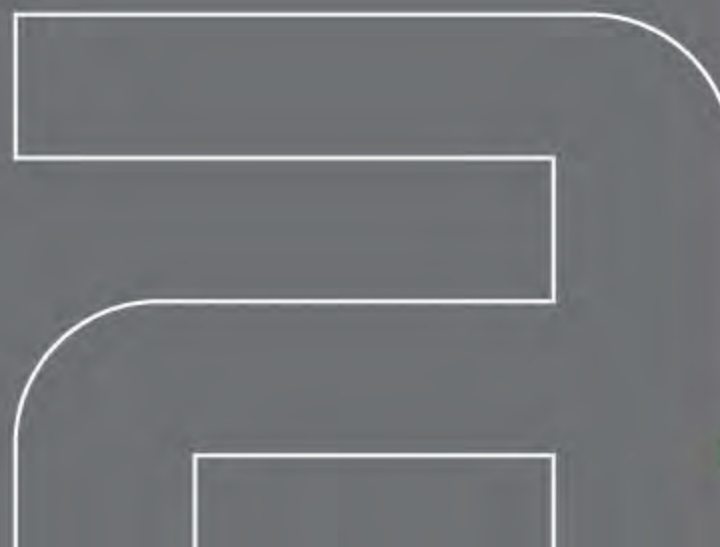

n° de piezas No. tiles	dimensiones expositor (mm) display dimensions			dimensiones embalaje (mm) packaging dimensions			peso (kg) weight
	A	B	H	A	B	H	
10P	280	805	1505	1550	620	300	60

