

Dimensiones / Dimensions

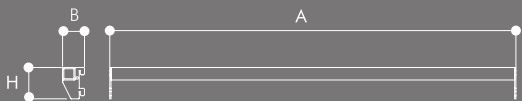

Acabado de serie opcionales / Optional finishes series



Blanco/White



Plata/Silver



Grafito/Graphite



Negro/Black

Iluminación de serie opcional / Optional lighting series

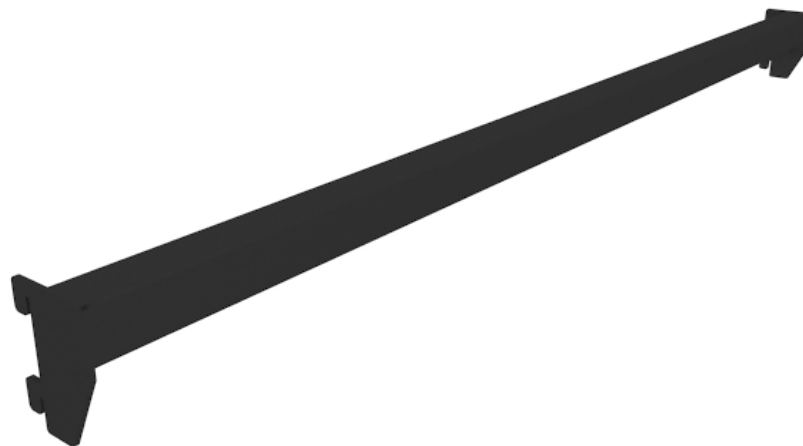
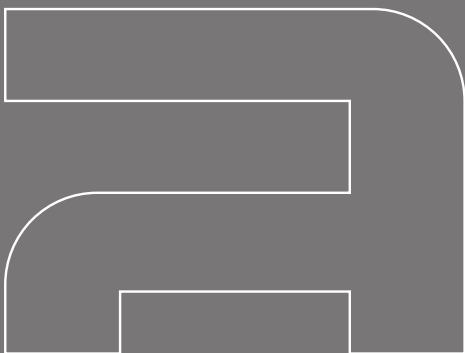

Imagen/Image
Rack C 1000

Ref:

dimensiones expositor (mm)
display dimensions (ft/inch)

A

B

H

973mm / 3'2"

52mm / 2"

75mm / 3"

El elemento que siempre se utilizará como parte de un conjunto.

Las dimensiones del conjunto, del embalaje y del peso, variarán dependiendo de la composición.

Element that will always be used as a part of a set in a technical area/wall.

Measures of the set, packing and weight would change depending of the choice of the elements.



Dimensiones / Dimensions

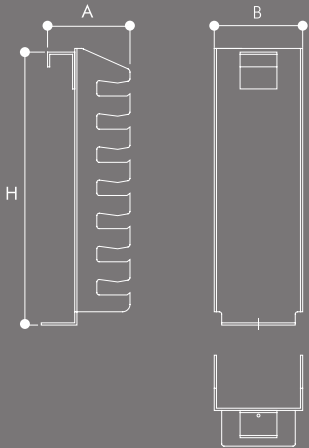

Acabado de serie opcionales / Optional finishes series



Iluminación de serie opcional / Optional lighting series

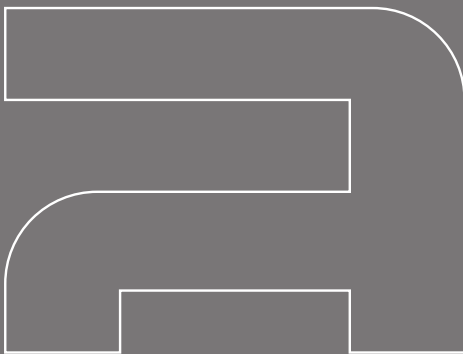

Imagen/Image
Cluster 9P

Ref:	nº de piezas No. tiles	dimensiones expositor (mm) display dimensions (ft/inch)		
		A	B	H
	7P	112mm / 4"	120mm / 5"	375mm / 1'3"
	9P	112mm / 4"	120mm / 5"	465mm / 1'6"
	14P	112mm / 4"	120mm / 5"	690mm / 2'3"
	20P	112mm / 4"	120mm / 5"	960mm / 3'2"

El elemento que siempre se utilizará como parte de un conjunto.

Las dimensiones del conjunto, del embalaje y del peso, variarán dependiendo de la composición.

Element that will always be used as a part of a set in a technical area/wall.

Measures of the set, packing and weight would change depending of the choice of the elements.



Dimensiones / Dimensions

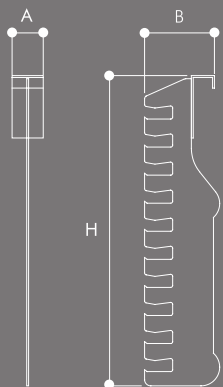

Acabado de serie opcionales / Optional finishes series



Blanco/White Plata/Silver Grafito/Graphite Negro/Black

Iluminación de serie opcional / Optional lighting series

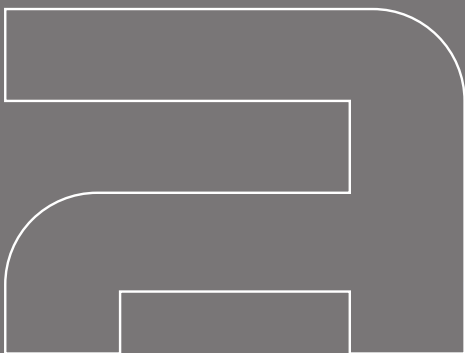

CLUSTER DUO
CUBE COLLECTION

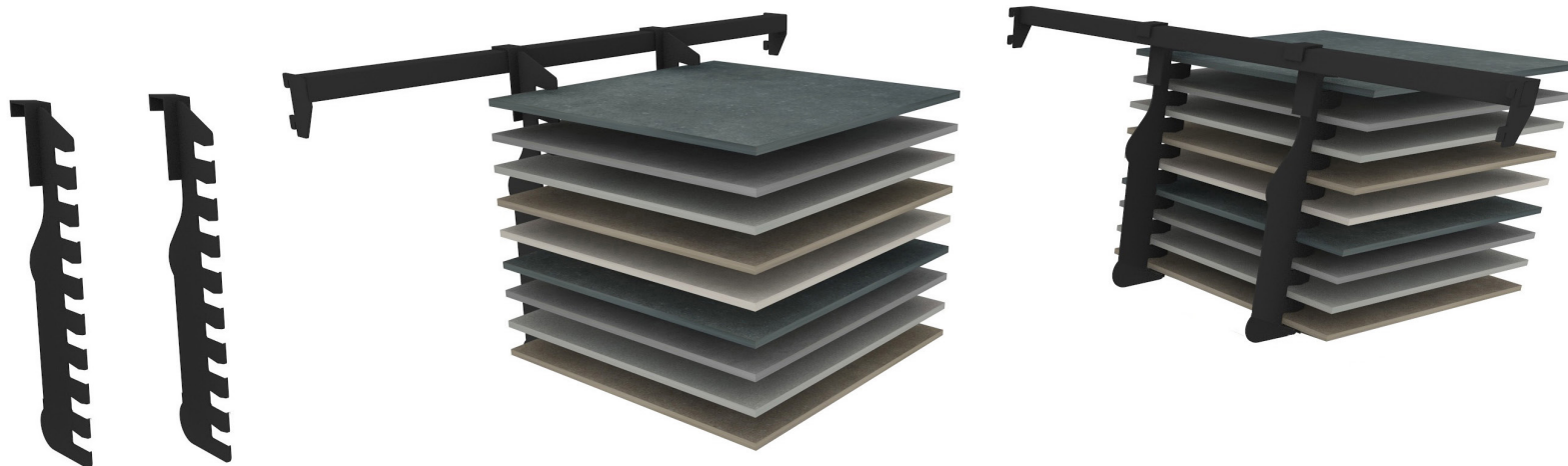

Imagen/Image
Cluster Duo 9P

Ref:	nº de piezas No. tiles	dimensiones (mm) dimensions (ft/inch)		
		A	B	H
7P (2 ud)		46mm / 2"	112mm / 4"	363mm / 1'2"
9P (2 ud)		46mm / 2"	112mm / 4"	453mm / 1'2"
14P (2 ud)		46mm / 2"	112mm / 4"	678mm / 1'2"
20P (2 ud)		46mm / 2"	112mm / 4"	948mm / 1'2"

El elemento que siempre se utilizará como parte de un conjunto.
Las dimensiones del conjunto, del embalaje y del peso, variarán dependiendo de la composición.

Element that will always be used as a part of a set in a technical area/wall.
Measures of the set, packing and weight would change depending of the choice of the elements.

Dimensiones / Dimensions

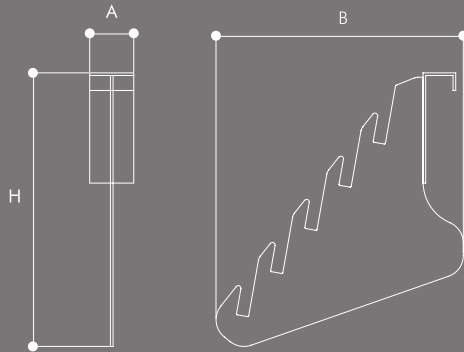

Acabado de serie opcionales / Optional finishes series

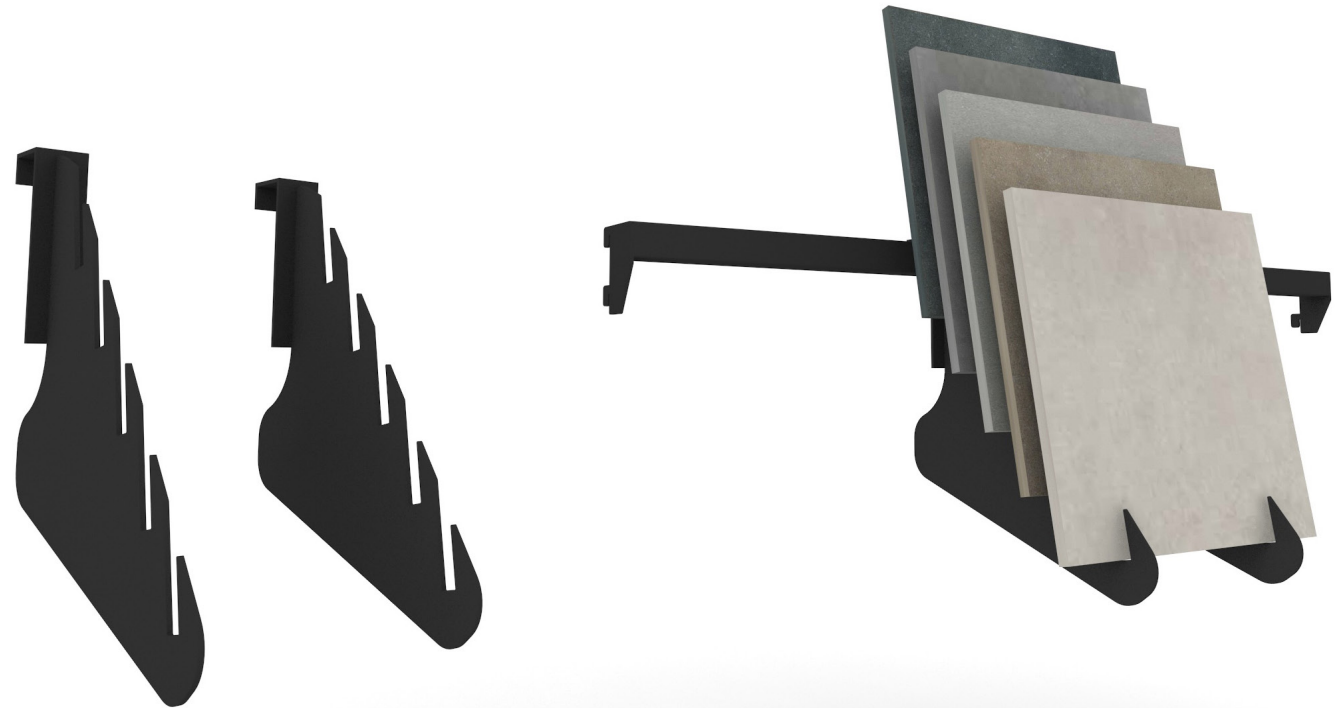

Imagen/Image
Comb Duo 5P

Ref:	nº de piezas No. tiles	dimensiones (mm) dimensions (ft/inch)		
		A	B	H
4P (2 Ud)		50mm / 2"	242mm / 10"	261mm / 10"
5P (2 Ud)		50mm / 2"	280mm / 11"	310mm / 1'
6P (2 Ud)		50mm / 2"	319mm / 1'1"	359mm / 1'2"

El elemento que siempre se utilizará como parte de un conjunto.

Las dimensiones del conjunto, del embalaje y del peso, variarán dependiendo de la composición.

Element that will always be used as a part of a set in a technical area/wall.

Measures of the set, packing and weight would change depending of the choice of the elements.



Dimensiones / Dimensions

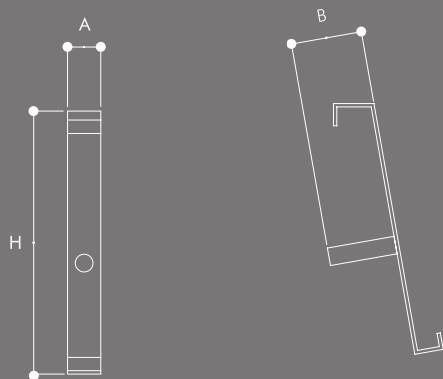

Acabado de serie opcionales / Optional finishes series



Imagen/Image
Support Duo

Ref:	dimensiones (mm) dimensions (ft/inch)			nº de piezas (mm) No. tiles (ft/inch)
	A	B	H	
	300mm / 1'	63mm / 2"	237mm / 9"	1 Und. 30 x 30 1 Und 1" x 1"
	450mm / 1'6"	89mm / 4"	387mm / 1'3"	1 Und. 30 x 30 1 Und 1" x 1"
	600mm / 2'	115mm / 5"	537mm / 1'9"	1 Und. 30 x 30 1 Und 1" x 1"

El elemento que siempre se utilizará como parte de un conjunto.
Las dimensiones del conjunto, del embalaje y del peso, variarán dependiendo de la composición.

Element that will always be used as a part of a set in a technical area/wall.
Measures of the set, packing and weight would change depending of the choice of the elements.



Dimensiones / Dimensions

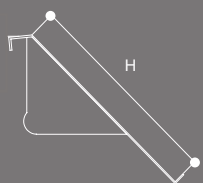

Acabado de serie opcionales / Optional finishes series

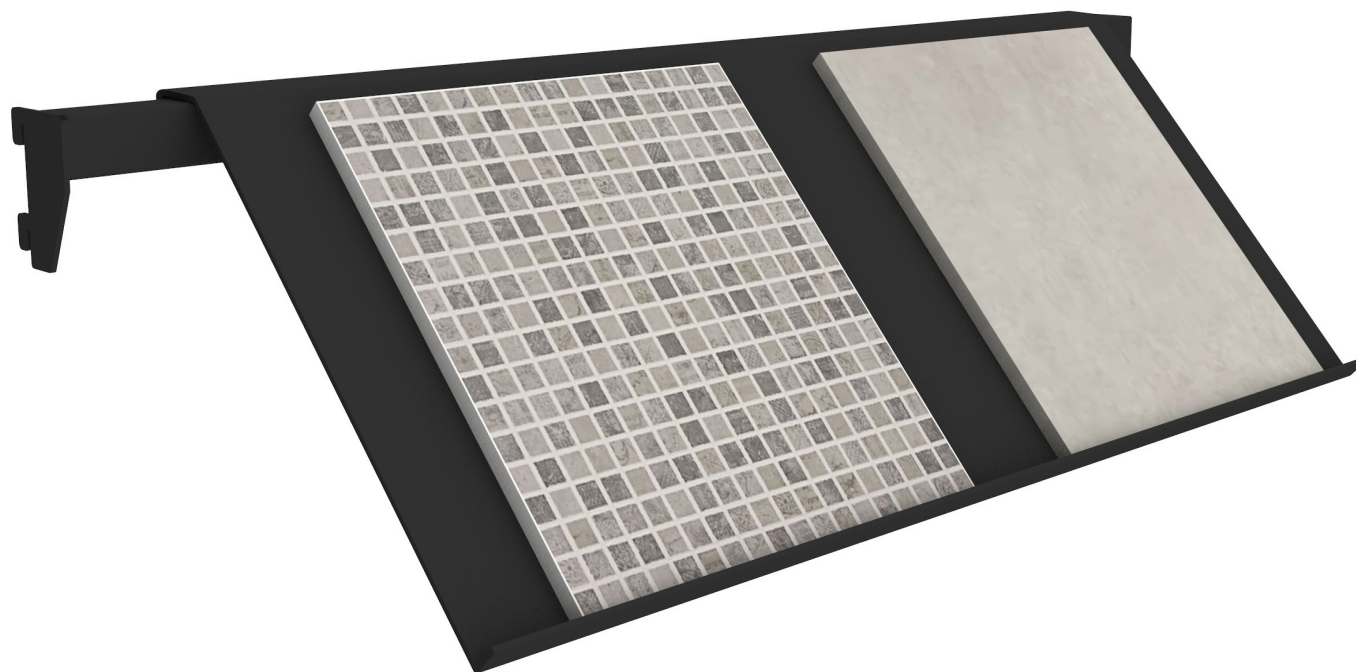

Imagen/Image
Cube Tray

Ref:	modelo model	dimensiones expositor (mm) display dimensions (ft/inch)		
		A	B	H
	Tray 300mm / 1'	900mm / 2'11"	283mm / 11"	240mm / 9"
	Tray 450 / 1'6"	900mm / 2'11"	390mm / 1'3"	347mm / 1'2"

El elemento que siempre se utilizará como parte de un conjunto.
Las dimensiones del conjunto, del embalaje y del peso, variarán dependiendo de la composición.

Element that will always be used as a part of a set in a technical area/wall.
Measures of the set, packing and weight would change depending of the choice of the elements.



Dimensiones / Dimensions

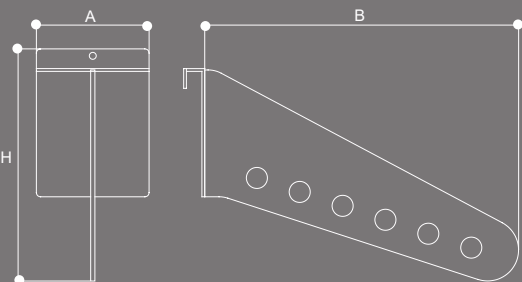

Acabado de serie opcionales / Optional finishes series

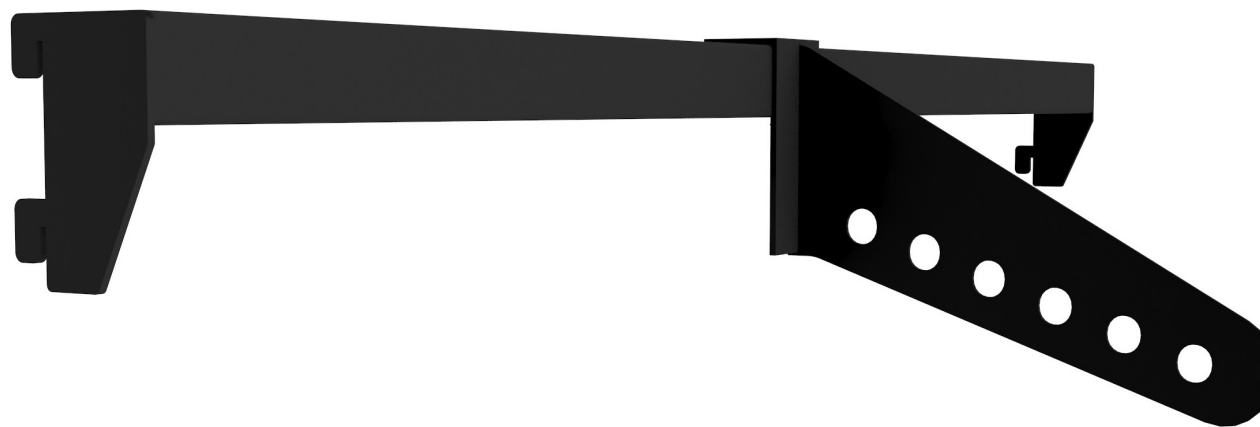
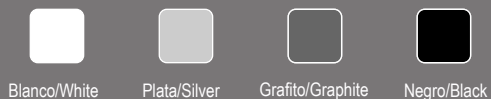

Imagen/Image
Hanger 6P

Ref:	modelo model	dimensiones expositor (mm) display dimensions (ft/inch)		
		A	B	H
	Hanger 6P	80mm / 3"	246mm / 9 1/2"	165mm / 6 1/2"

El elemento que siempre se utilizará como parte de un conjunto.
Las dimensiones del conjunto, del embalaje y del peso, variarán dependiendo de la composición.

Element that will always be used as a part of a set in a technical area/wall.
Measures of the set, packing and weight would change depending of the choice of the elements.

